

heat transfer specialists

**HEAT-TRANS**



HEAT TRANSFER SYSTEMS
www.heattrans.co.nz

“creating healthier homes”

HEAT•TRANS

Heat Trans systems use excess heat to warm other areas of the home by transferring it from one room to multiple rooms.

Heat Trans is the professional brand in heat transfer systems and is the brand of choice for contractors. Leading the market for over 15 years, Heat Trans is at the forefront of product development and innovation and is the only heat transfer system using acoustic insulated duct and digital controllers.

Typical home heating concentrates on warming the lounge, which means you are often 'Hot' in one room while the rest of the house is unbearably cold. HeatTrans overcomes this issue by effectively transferring the excess heat from this room to other rooms in the home.



How does Heat Trans work?

- 1 Excess heat from your heat source will rise to ceiling level where it is trapped. This excess heat can reach temperatures of 30-35°C
- 2 This excess heat can be effectively transferred to other rooms using a high quality fan and acoustic insulated duct.
- 3 Air moves from the bedrooms back to the lounge creating a natural re-circulation of warm, dry air throughout the home. This will also make your home healthier by helping to reduce mould and mildew.

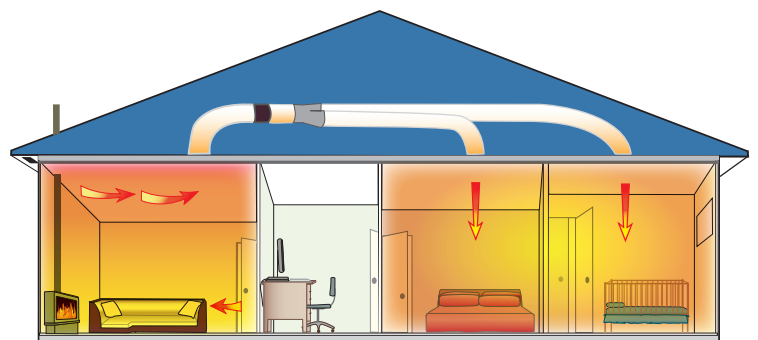
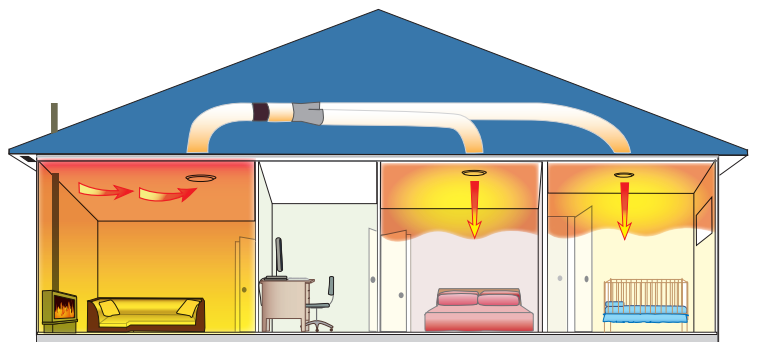
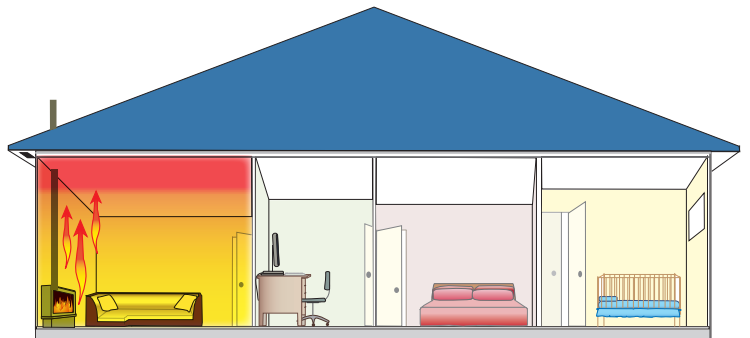

Heat Trans systems utilise excess heat throughout the home and cost as little as a light bulb to run.

www.heattrans.co.nz

Heat Trans Features

Ultecon digital thermostat controllers measure and display the temperature of your lounge and let you preset your preferred room temperature.

When your lounge temperature exceeds your preferred room temperature the system will automatically start to transfer the excess heat to other rooms in your home.

The 2 and 3 room systems also offer fan speed control, which allows you to set your preferred fan speed giving you ultimate control over the volume of heated air being transferred.



One Room



Two/Three Room



superior fans

High quality multi-speed fans for optimum airflow ventilation in the home that cost as little as a light bulb (between 38W and 120W) to run. These high quality fans have been specifically selected to ensure correct airflow and pressure levels are achieved.



whisper quiet

The unique acoustic insulated duct reduces air transfer noise to a 'whisper quiet' level. Better temperature retention is achieved, ensuring optimal heat transfer of excess warm air.

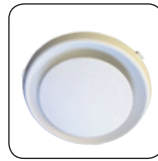

adjustable diffusers

Easily adjustable to allow balancing of the airflow into each room. Simply twist the centre section of the diffuser to allow more or less air into each room. Or simply close any diffuser when the room is not in use.

Optional extras

summer feature

Introduce fresher cooler air into your home in summer with the Summer-Vent Extension Kit, to enable year round use of your system.

With the inlet grille installed under your soffit, fresher cooler air is filtered using a high efficiency F7 filter and is distributed throughout your home via your Heat Trans outlets. The system is controlled via a standard wall switch which operates the motorised damper to start drawing air from outside.

Note: When the summer feature is working the lounge/source room inlet is switched off via the damper and will not receive the cooled air directly from outside, however due to air pressure a natural re-circulation occurs throughout the home.

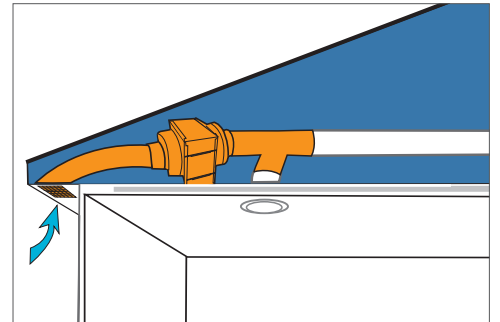

extension kit

The Pro-Series One Outlet Extension Kit is designed to extend your standard three room HeatTrans system so you can distribute warm air to an extra room within your home. By adding additional outlet/s to your system you are simply dividing the available heated air amongst more rooms.

All Heat Trans systems can be extended as follows:

1 Room System - 6 metres supplied: can be extended to 12 metres

2 Room System - 12 metres supplied:
any one duct length can be extended up to 18 metres from inlet to outlet.

3 Room System - 15 metres supplied:
any one duct length can be extended up to 21 metres from inlet to outlet.

For more indepth details on this please see Bulletin 49 at: www.heattrans.co.nz

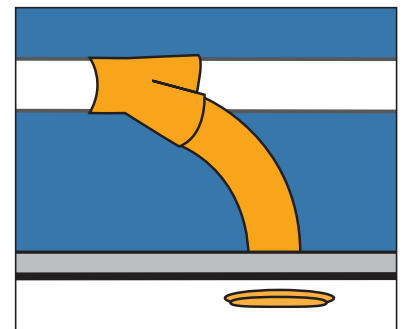

Heat Trans Systems

One Room Kit

- 1 x Ultecon Digital Thermostat Controller
- 1 x 150mm High Performance Axial Flow Fan
- 1 x 3 Metres - 150mm Acoustic Insulated Duct
- 1 x 3 Metres - 150mm Insulated Duct
- 1 x Circular Inlet Grille
- 1 x Adjustable Circular Design Outlet Diffuser
- 2 x 45mm x 5 Metre Duct Tape

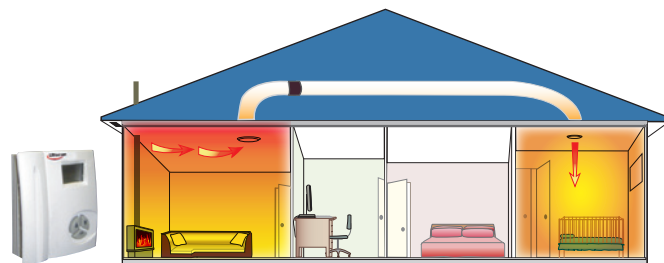

Order Code:FAN0325

Two Room Kit

- 1 x Ultecon Digital Thermostat/ Fan Speed Controller
- 1 x 150mm Multi-Speed High Performance Fan
- 2 x 3 Metres - 150mm Acoustic Insulated Duct
- 2 x 3 Metres - 150mm Insulated Duct
- 1 x Y Branch
- 1 x Circular Inlet Grille
- 2 x Adjustable Circular Design Outlet Diffusers
- 3 x 45mm x 5 Metre Duct Tape

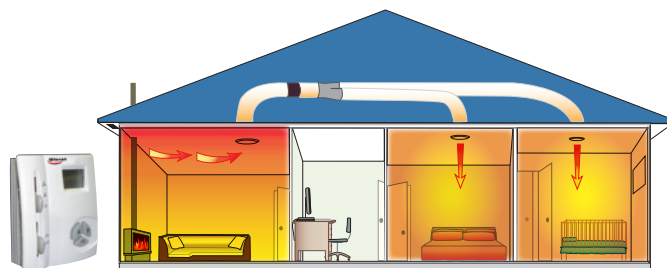

Order Code:FAN0337

Three Room Kit

- 1 x Ultecon Digital Thermostat/ Fan Speed Controller
- 1 x 200mm Multi-Speed High Performance Fan
- 3 x 3 Metres - 150mm Acoustic Insulated Duct
- 2 x 3 Metres - 200mm Insulated Duct
- 1 x Double Branch Take-Off (Three Way Splitter)
- 1 x Circular Inlet Grille
- 3 x Adjustable Circular Design Outlet Diffusers
- 1 x 48mm x 30 Metre Duct Tape

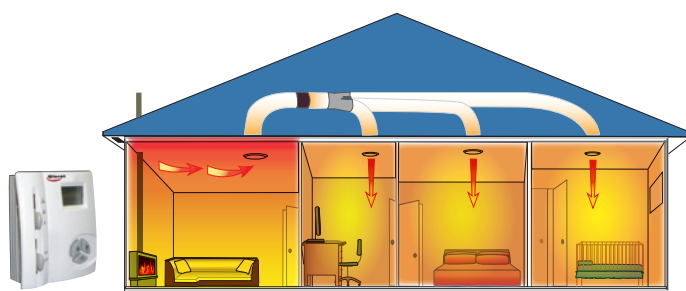

Order Code:FAN0338

Pro-Series One Outlet Extension Kit

- 1 x Y Branch (Splitter)
- 1 x 3 Metres - 150mm Acoustic Insulated Duct
- 1 x Adjustable Circular Design Outlet Diffuser
- 2 x 48mm x 5 Metre Duct Tape

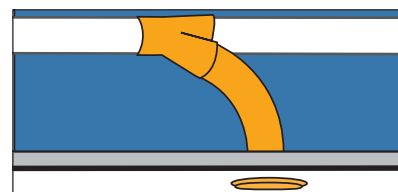

Order Code:DCT2101

Summer Vent Extension Kit

- 1 x Branch Take Off (Splitter) including Motorised Dampers
 - 1 x 200mm F7 Filter Box
 - 1 x 3 Metres - 200mm Insulated Duct
 - 1 x 200mm Fixed Grille
 - 2 x 48mm x 5 Metre Duct Tape
 - 2 x 200/150 reducers (only required if adding to a one or two room Heat Trans system)
- (Electrical: single pole, double throw 230 volt rated wall switch required - **not included**)

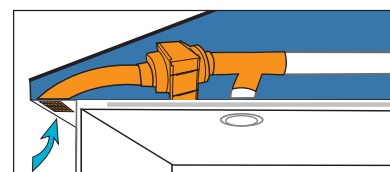

Order Code:DCT1481

Thru-Wall Kit

- 1 x 100mm Axial Flow Fan
 - 1 x 400mm - 100mm Diameter Duct
 - 1 x Fixed Grille
- Fittings and Fixings Included



Order Code:FAN0005

HEAT•TRANS

Distributed by Securimax
(a trading name of Simx Limited)
PO Box 14 347, Panmure, Auckland, New Zealand.
P: (09) 259 1660 E: enquiry@heattrans.co.nz
W: www.heattrans.co.nz

Securimax reserves the right to alter specifications without notice.

Dealers Details